

Snap Circuits® Beginner

Instruction Manual

AGES
5+

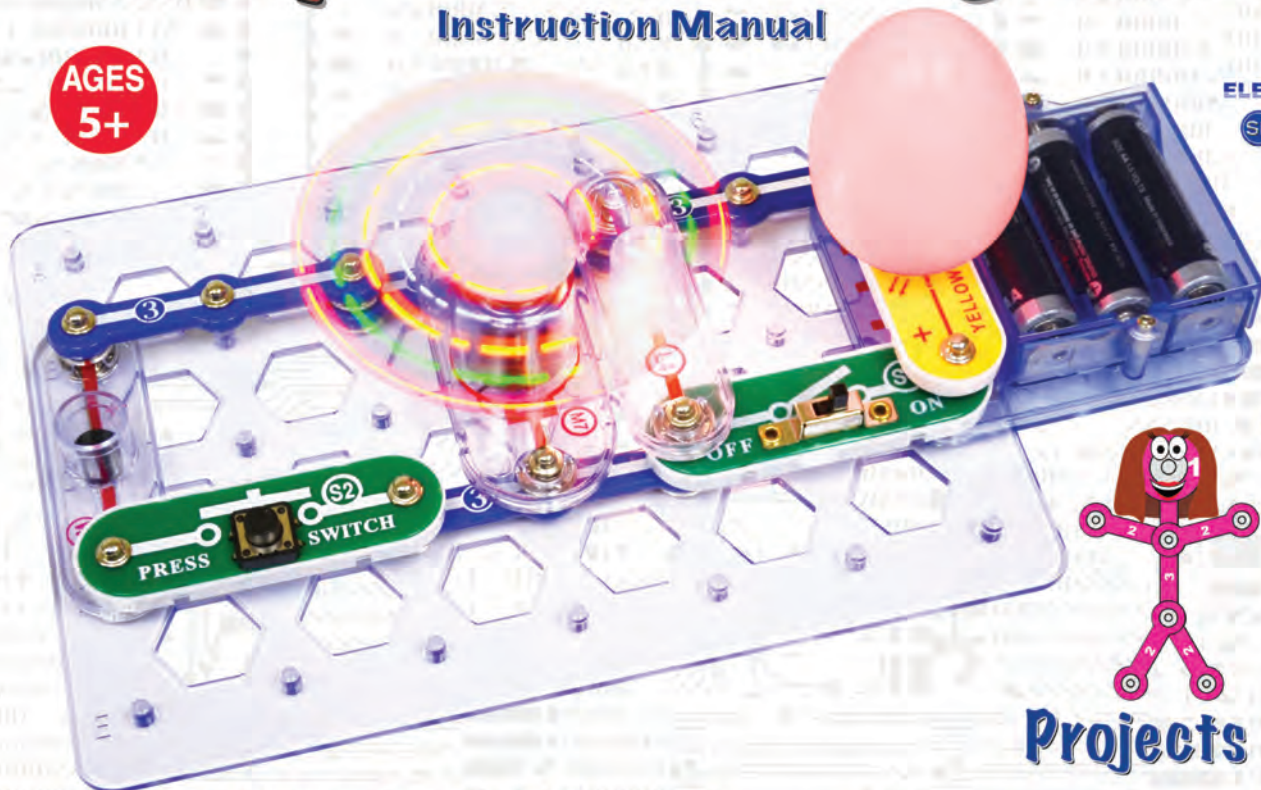

Projects 1-21

Table of Contents

Warnings	1
Parts List	2
How to use it	3
Basic Troubleshooting	4
Advanced Troubleshooting	4
Project Listings	5
Projects 1 - 21	6 - 26

WARNING:

Always check your wiring before turning on a circuit. Never leave a circuit unattended while the batteries are installed. Never connect additional batteries or any other power sources to your circuits. Discard any cracked or broken parts.

Adult Supervision:

Because children's abilities vary so much, even with age groups, adults should exercise discretion as to which

experiments are suitable and safe (the instructions should enable supervising adults to establish the experiment's suitability for the child). Make sure your child understands and follows all of the safety warnings, and keeps them at hand for reference.

Never modify your parts, as doing so may disable important safety features in them, and could put your child at risk of injury.

Batteries:

- Use only 1.5V AA type, alkaline batteries (not included).
- Insert batteries with correct polarity.
- Do not mix old and new batteries.
- Remove batteries when they are used up.
- Do not mix alkaline, standard (carbon-zinc), or rechargeable (nickel-cadmium) batteries.
- Do not connect batteries or battery holders in parallel.
- Do not short circuit the battery terminals.
- Never throw batteries in a fire or attempt to open its outer casing.
- Batteries are harmful if swallowed, so keep away from small children.

Conforms to all applicable US government requirements.



WARNING: SHOCK HAZARD

Never connect Snap Circuits® to the electrical outlets in your home in any way!







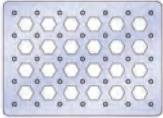

WARNING: MOVING PARTS

Do not touch the light motor (M7) during operation.

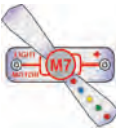
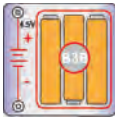

Parts List (Colors and styles may vary) Symbols and Numbers

Important: If any parts are missing or damaged, **DO NOT RETURN TO RETAILER.** Call customer service toll-free at (800) 533-2441 or e-mail us at: help@elenco.com.

Qty.	ID	Name	Symbol	Part #	Qty.	ID	Name	Symbol	Part #
□ 1		Mini Base Grid (7.7" x 5.5")		6SCBGM	□ 1	(L4)	Lamp		6SCL4
□ 4	(3)	3-Snap Wire		6SC03	□ 1	(M7)	Light Motor		6SCM7
□ 1	(B3B)	Battery Holder - uses 3 1.5V type AA (not included)		6SCB3B	□ 1	(S1)	Slide Switch		6SCS1
□ 1	(D10)	Red/Yellow LED		6SCD10	□ 1	(S2)	Press Switch		6SCS2
□ 1		Egg		6SCEGG	□ 1	(W1)	Horn		6SCW1

How To Use It

For each project, follow the drawings to place all STEP 1 parts on the mini base grid, then place all STEP 2 parts, then place any additional parts indicated by STEPS 3 or 4.

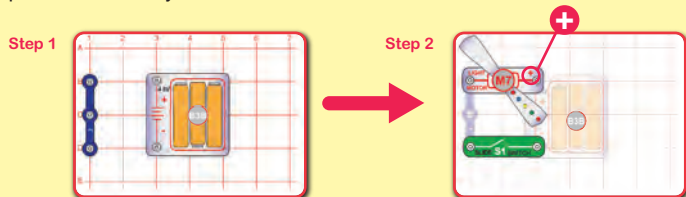

Activate the circuit using the slide switch (S1) or press switch (S2) as indicated in the final step.



Be sure that the light motor (M7), red/yellow LED (D10), and horn (W1) have their "+" marking positioned as per the drawing.



Do not touch the light motor (M7) during operation.



Note: While building the projects, be careful not to accidentally make a direct connection across the battery holder (a "short circuit"), as this may damage and/or quickly drain the batteries.



How to add or replace batteries

Remove the safety cover from the battery holder (B3B) with a Phillips head screwdriver. Insert three (3) 1.5V "AA" batteries (not included) into the battery holder (B3B). Be sure to orient the battery "+" side as marked in the holder. Replace battery holder cover.

Examples of SHORT CIRCUITS - NEVER DO THESE!!!

Placing a 3-snap wire directly across the batteries is a SHORT CIRCUIT.

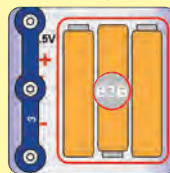

When the slide switch (S1) is turned on, this circuit has a SHORT CIRCUIT path (as shown by the arrows). The short circuit prevents any other portions of the circuit from ever working.

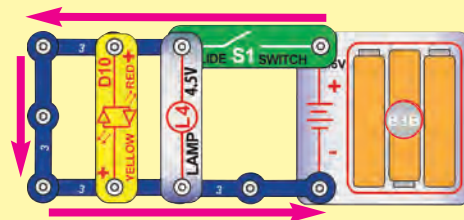

Troubleshooting

Basic Troubleshooting:

1. Most circuit problems are due to incorrect assembly, always double-check that your circuit exactly matches the drawing for it.
2. Be sure that the light motor (M7), red/yellow LED (D10), and horn (W1) have their “+” marking positioned as per the drawing.
3. Be sure that all connections are securely snapped.
4. Try replacing the batteries.

Advanced Troubleshooting (Adult supervision recommended):

If you suspect you have damaged parts, you can follow this procedure to systematically determine which ones need replacing:

1. **Lamp (L4), red/yellow LED (D10), horn (W1), light motor (M7), and battery holder (B7):**
 - A. Place batteries in holder.
 - B. Place the lamp directly across the battery holder, it should light. C. Do the same with the LED, it should light red or yellow, depending on how you oriented it.
 - D. Do the same with the horn (horn + to battery +), it should make an annoying sound.
 - E. Do the same with the light motor (motor + to battery +), it should spin to the right and its lights should be on.
 - F. If nothing works, then replace your batteries and repeat, if still bad then the battery holder is damaged.
2. **3-snap wires:** Build the Lamp circuit (on page 8), but replace the slide switch (S1) with a 3-snap wire; if the lamp (L4) does not light then one of the two 3-snap wires in the circuit is broken. Systematically test all four 3-snap wires in your set.
3. **Slide switch (S1) and press switch (S2):** Build the Lamp circuit (on page 8); if the lamp (L4) does not light then the slide switch is broken. Replace the slide switch with the press switch and test it in the same way.

Customer Service

Call toll-free: (800) 533-2441
e-mail: help@elenco.com

Project Listings

Project #	Description	Page #	Project #	Description	Page #
1	Light Motor	6	12	Super Dim Lights	17
2	Fan	7	13	2-Switch Light	18
3	Lamp	8	14	Either Switch Lamp	19
4	Red Light	9	15	Press Light Control	20
5	Yellow Light	10	16	Sound or Motion	21
6	Horn	11	17	2-Color Light & Sound	22
7	Light & Sound	12	18	Fun with Sound & Lights	23
8	Light & Sound with Egg	13	19	Fun with Switches	24
9	2-Speed Fan	14	20	Lots of Lights	25
10	2-Switch Everything	15	21	Egg Horn	26
11	Dim Lights	16			

Project 1 : Light Motor

Step 1

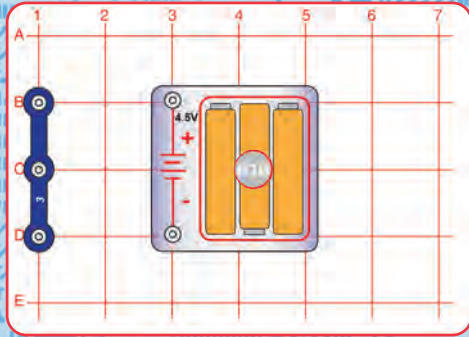

Step 2

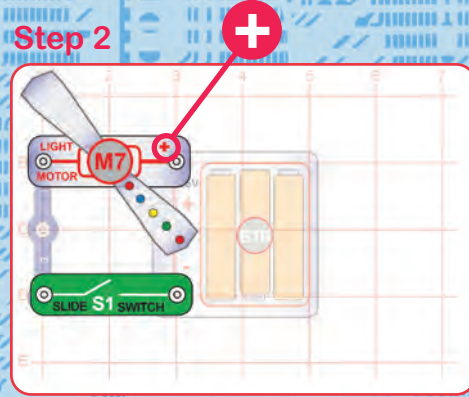

Step 3

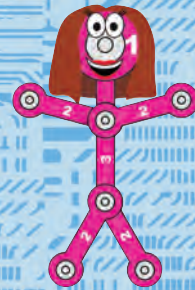
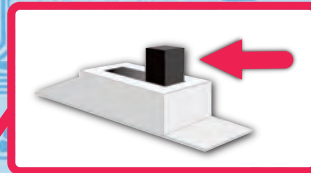
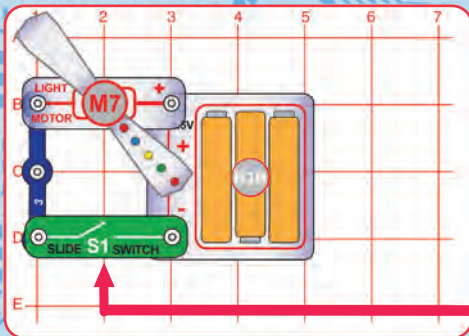

WARNING: MOVING PARTS
⚠ Do not touch the light motor (M7) during operation.

Project 2: Fan

Step 1

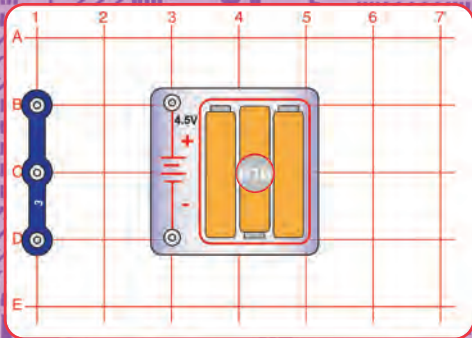

Step 2

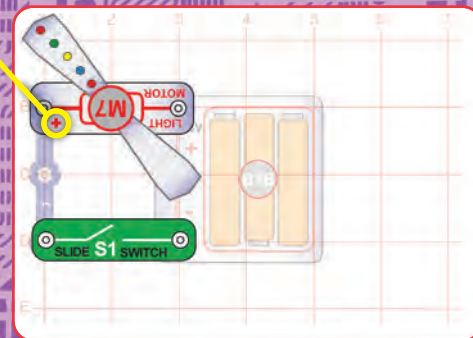

Step 3

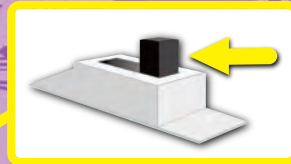
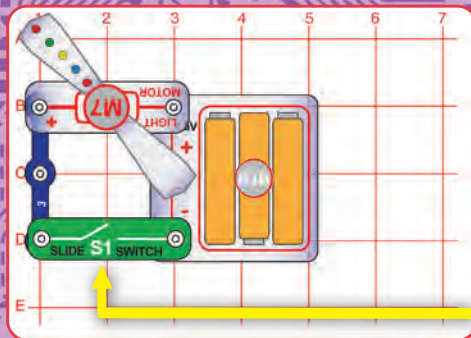

WARNING: MOVING PARTS
⚠ Do not touch the light motor (M7) during operation.

Project 3 : Lamp

Step 1

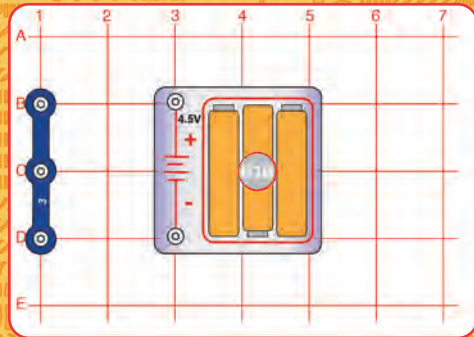

Step 2

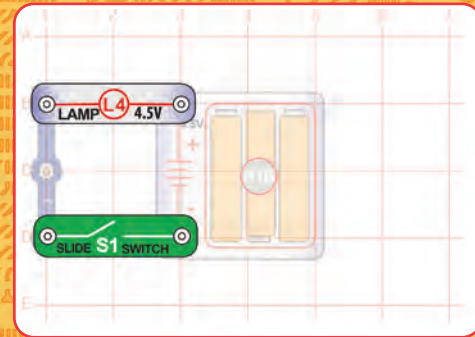

Step 3

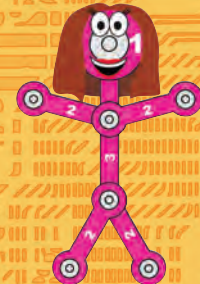
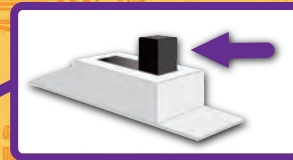
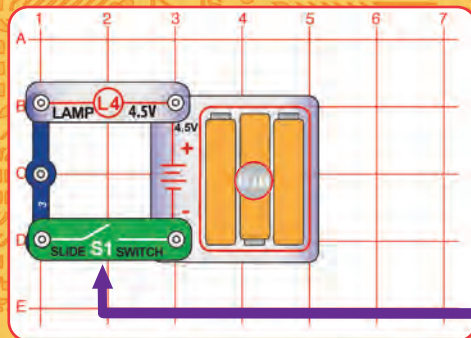

Project 4: Red Light

Step 1

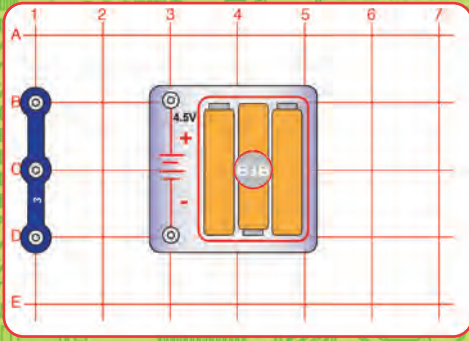

Step 2

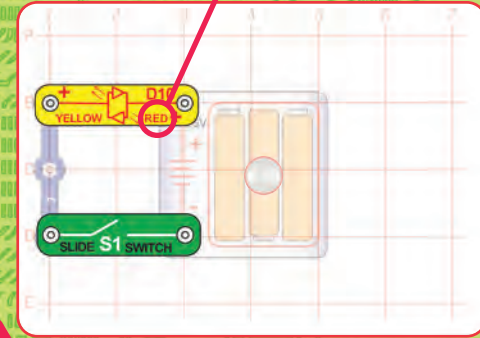

Step 3

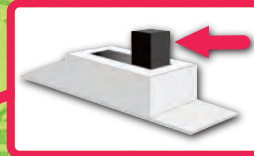
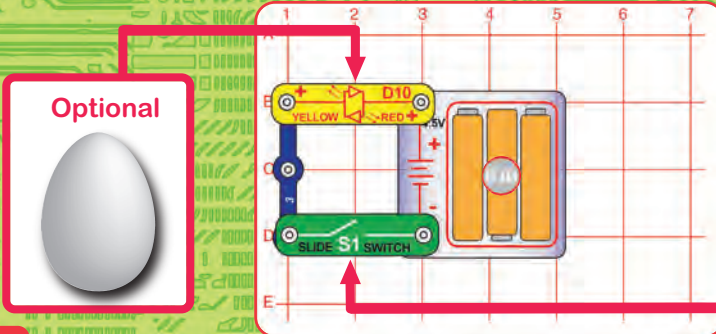

Project 5 : Yellow Light

Step 1

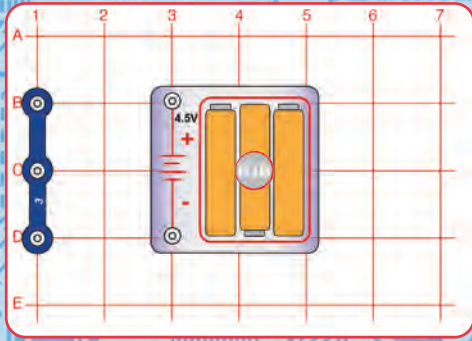

Step 2

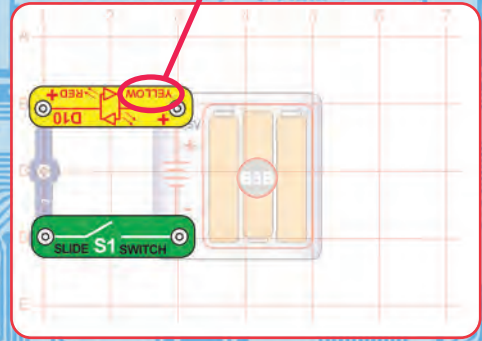

Step 3

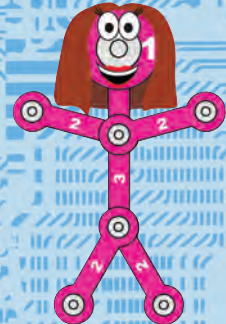
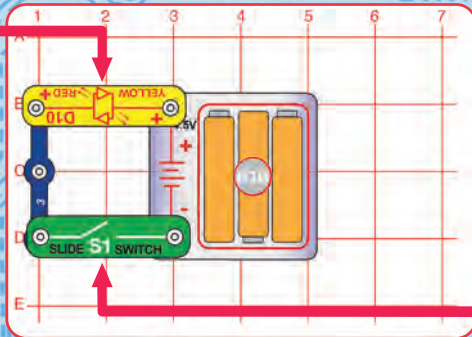
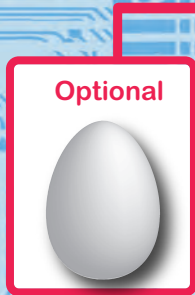

Project 6 : Horn

Step 1

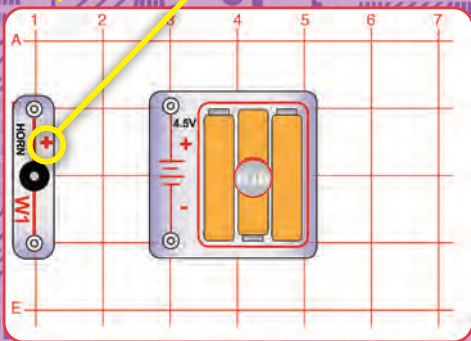

Step 2

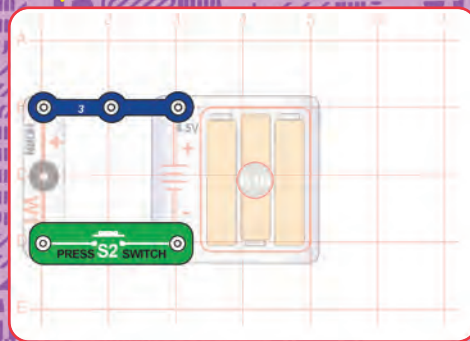

Step 3

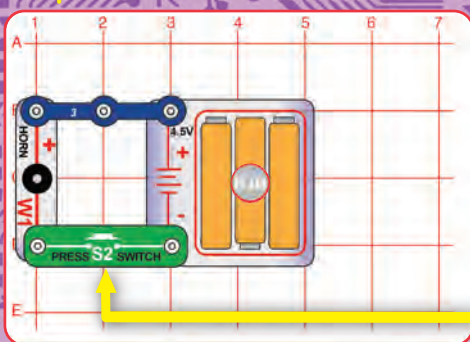

Project 7: Light & Sound

Step 1

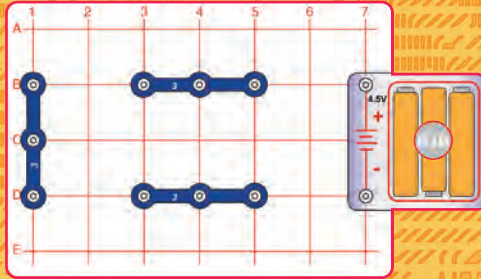

Step 2

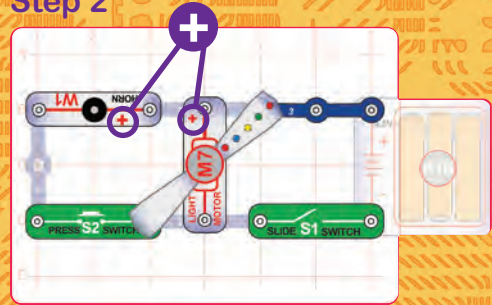

Step 3

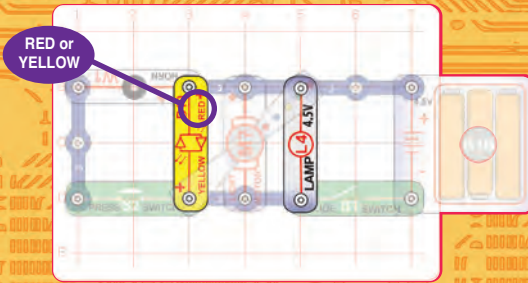

Step 4

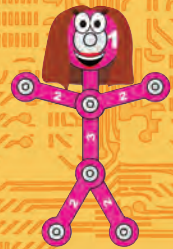
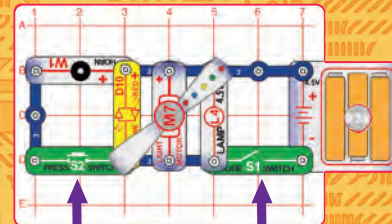

WARNING: MOVING PARTS
Do not touch the light motor (M7) during operation.



Project 9 : 2-Speed Fan

WARNING: MOVING PARTS
Do not touch the light motor (M7) during operation.

Step 1

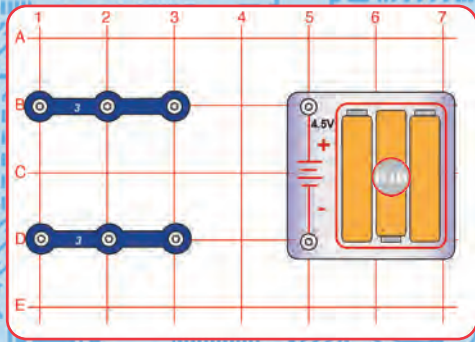

Step 2

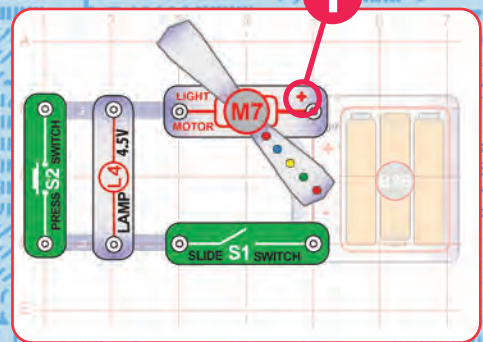

Step 3

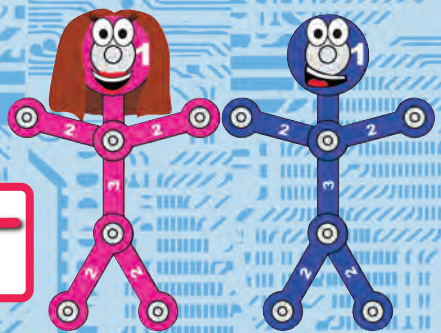
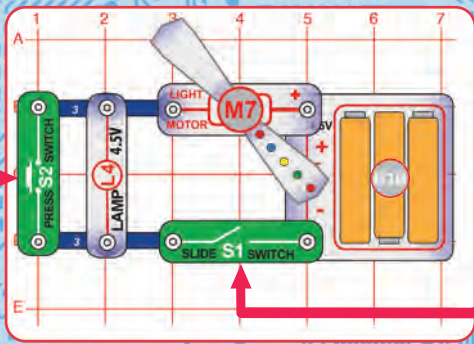

Project 10 : 2-Switch Everything

WARNING: MOVING PARTS
Do not touch the light motor (M7) during operation.

Step 1

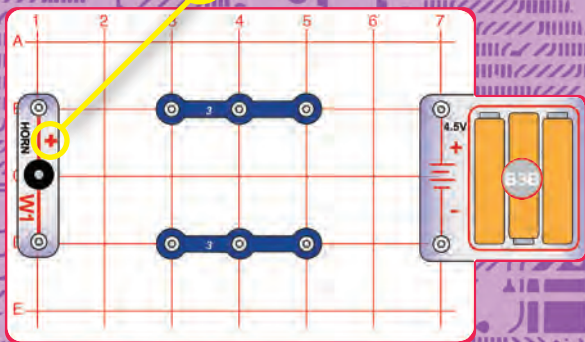

Step 2

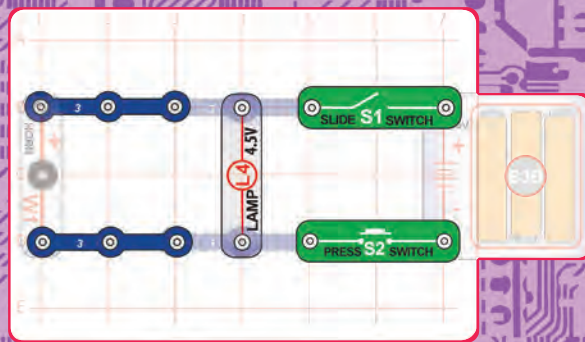

Step 3

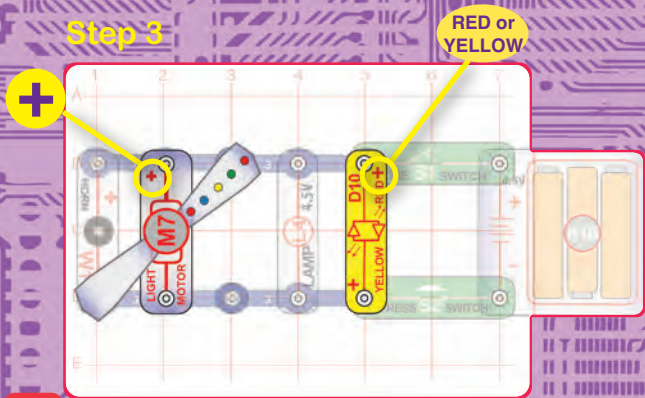

Step 4

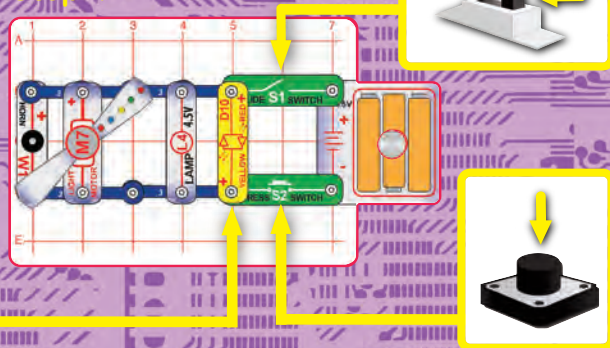

Project 11 : Dim Lights

WARNING: MOVING PARTS
⚠ Do not touch the light motor (M7) during operation.

Step 1

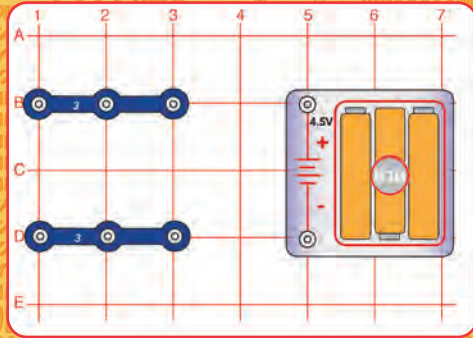

Step 2

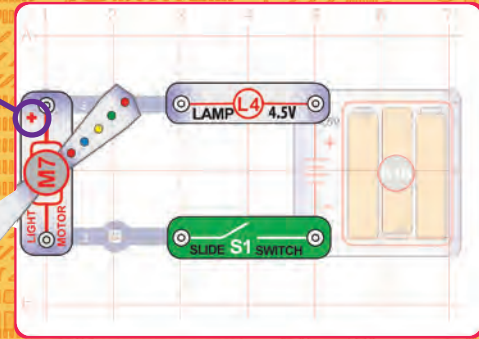

Step 3

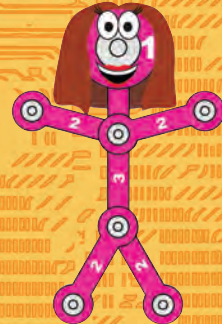
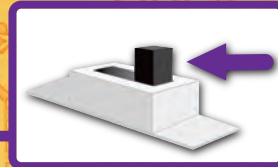
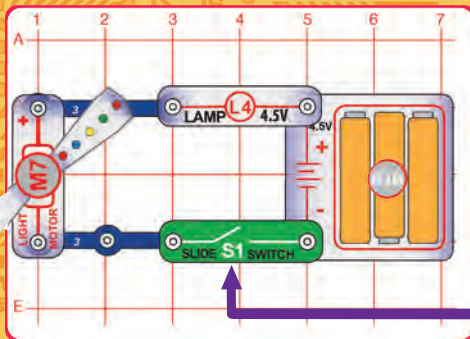

Project 12 : Super Dim Lights

WARNING: MOVING PARTS
Do not touch the light motor (M7) during operation.

Step 1

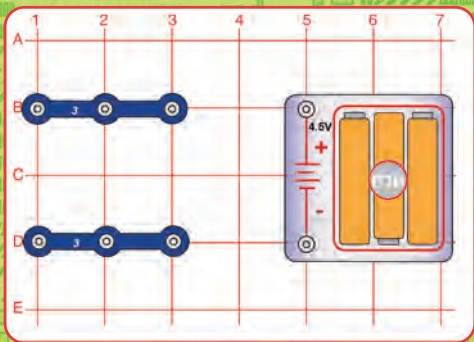

Step 2

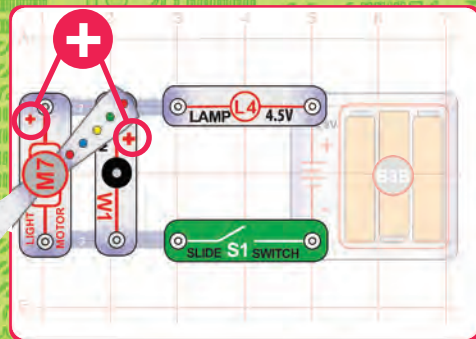

Step 3

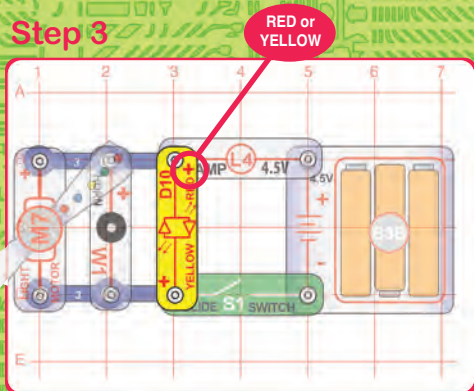

Step 4

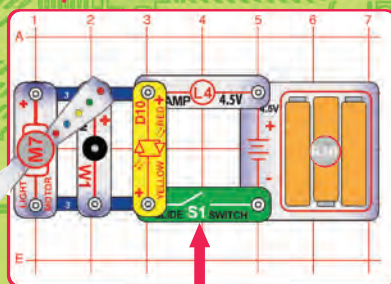

Project 13 : 2-Switch Light

Step 1

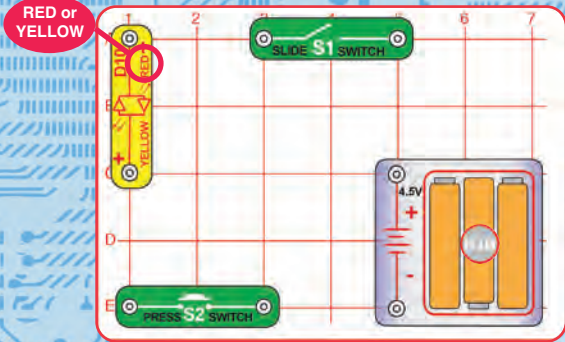

Step 2

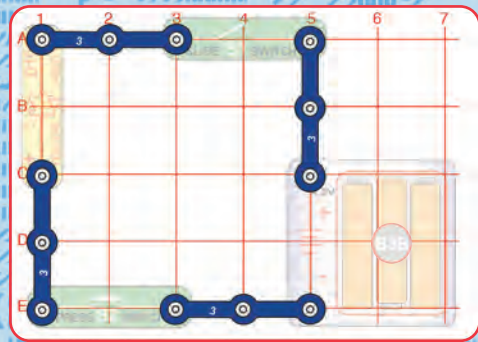

Step 3

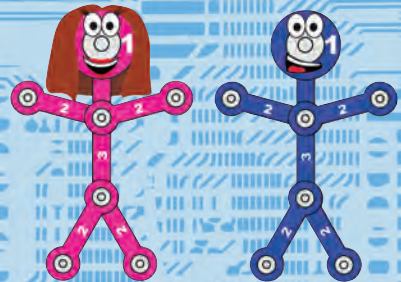
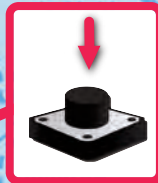
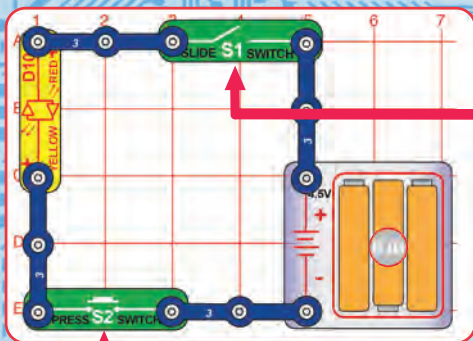

Project 14 : Either Switch Lamp

Step 1

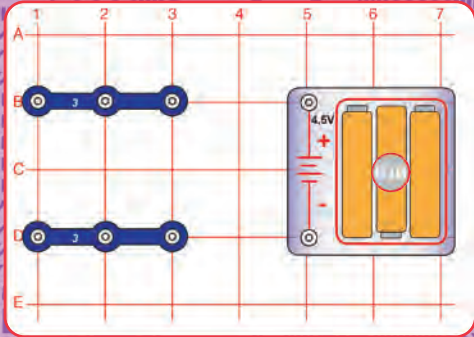

Step 2

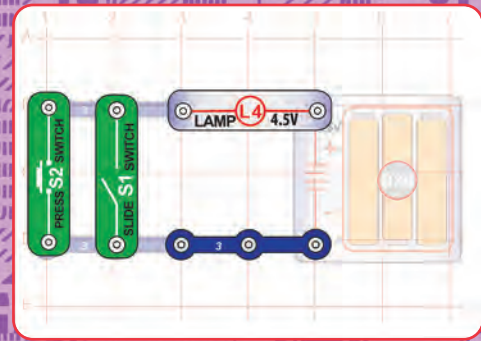

Step 3

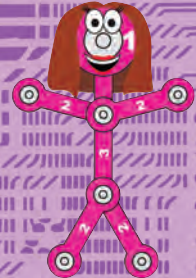
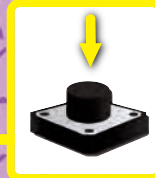
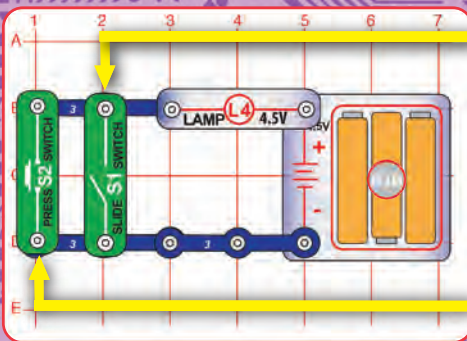

Project 15 : Press Light Control

Step 1

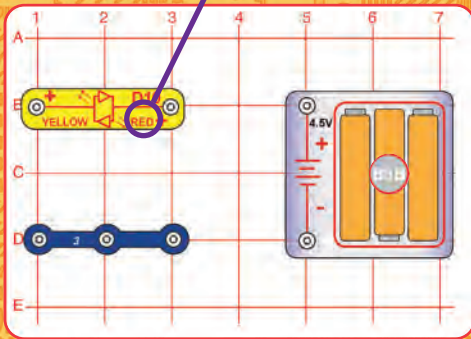

Step 2

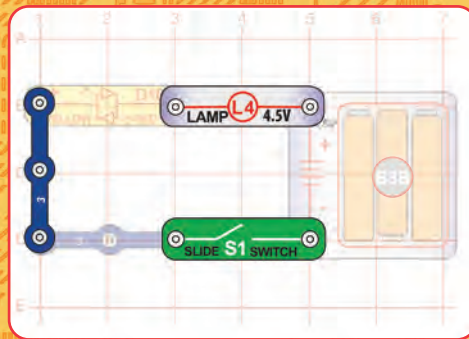

Step 3

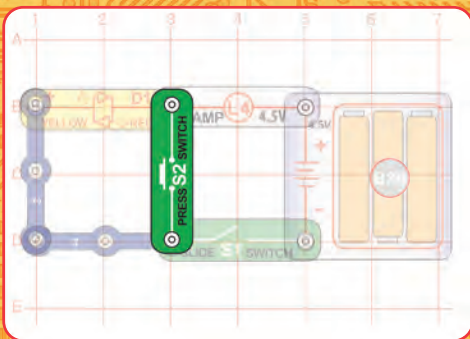

Step 4

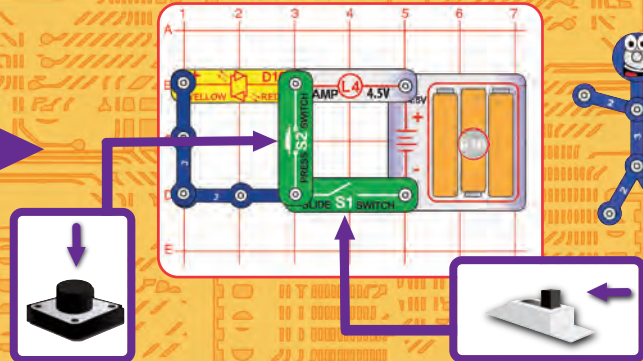

Project 16 : Sound or Motion

Step 1

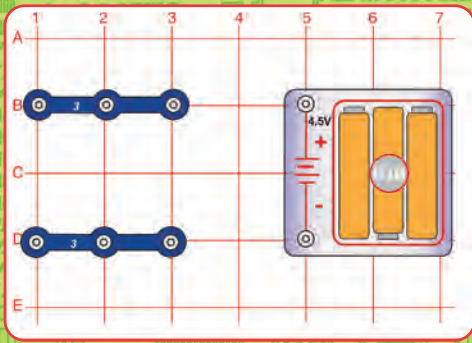

Step 2

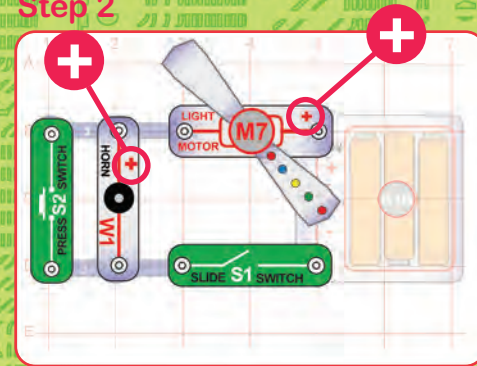

Step 3

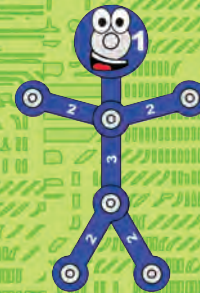
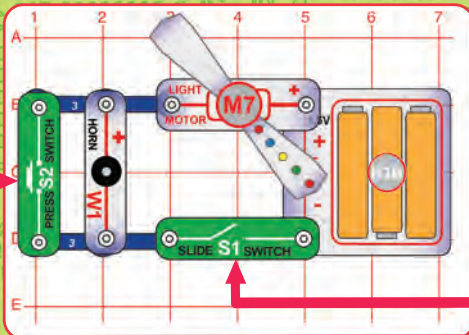

WARNING: MOVING PARTS
⚠ Do not touch the light motor (M7) during operation.

Project 17 : 2-Color Light & Sound

WARNING: MOVING PARTS
⚠ Do not touch the light motor (M7) during operation.

Step 1

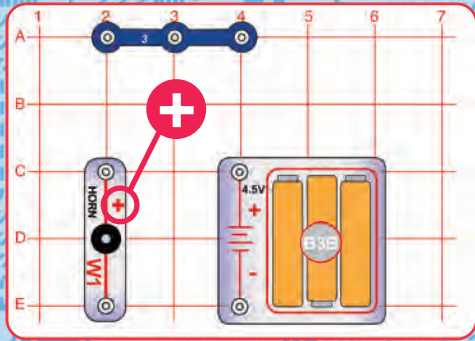

Step 2

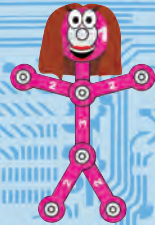
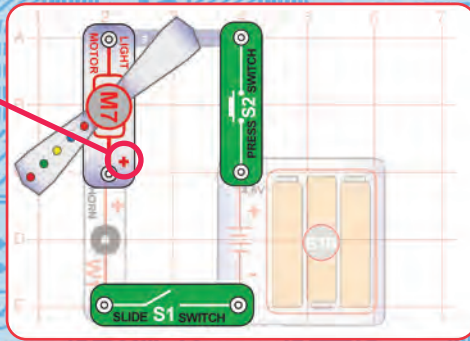

Step 3

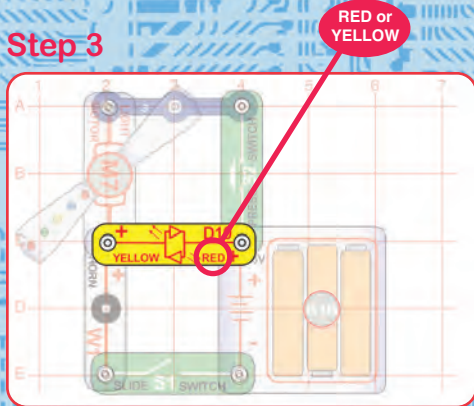

Step 4

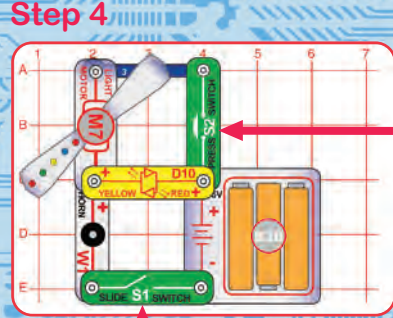

Project 18 : Fun with Sound & Lights

Step 1

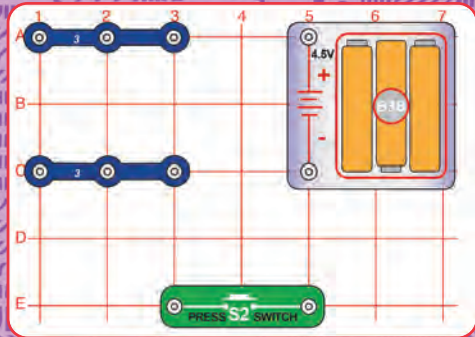

Step 2

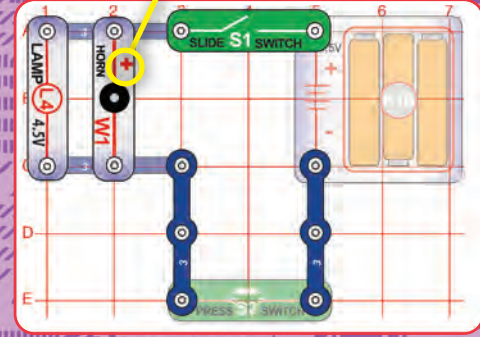

Step 3

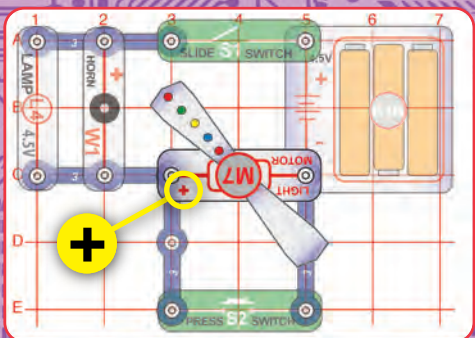

Step 4

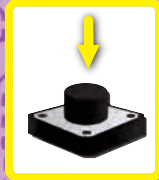
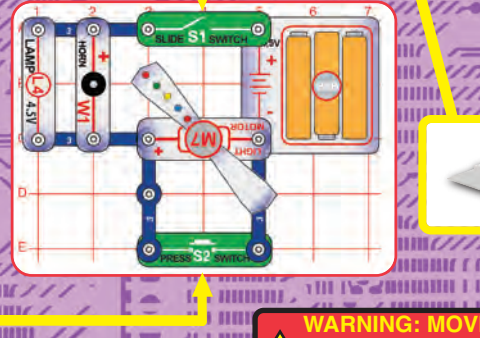

WARNING: MOVING PARTS
⚠ Do not touch the light motor (M7) during operation.

Project 19 : Fun with Switches

WARNING: MOVING PARTS
⚠ Do not touch the light motor (M7) during operation.

Step 1

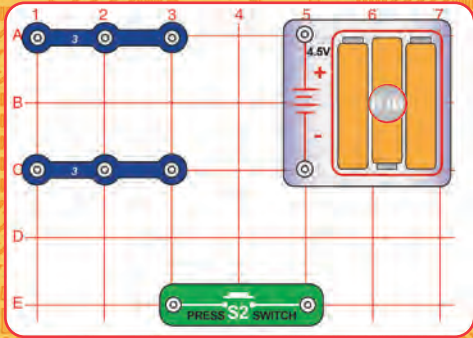

Step 2

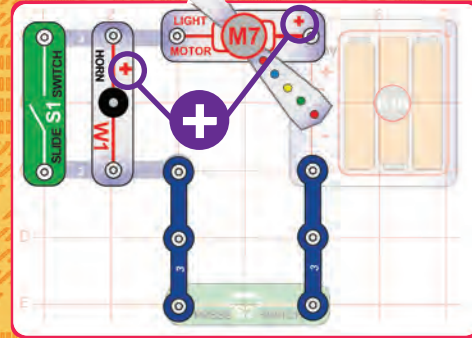

Step 3

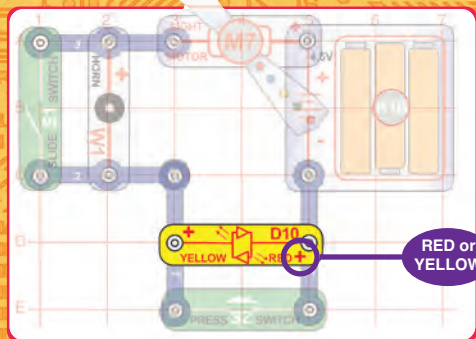

Step 4

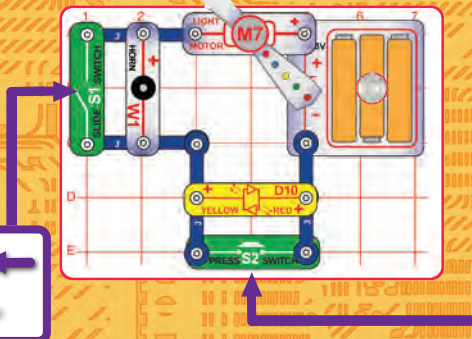

Project 20 : Lots of Lights

WARNING: MOVING PARTS
⚠ Do not touch the light motor (M7) during operation.

Step 1

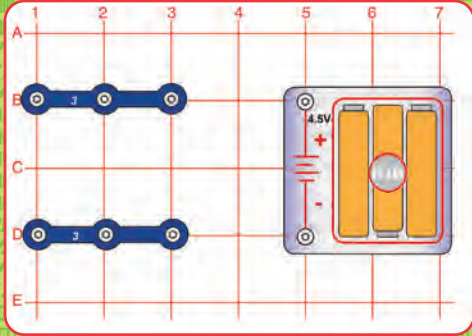

Step 2

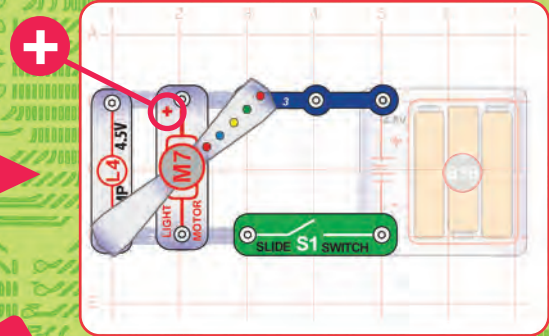

Step 3

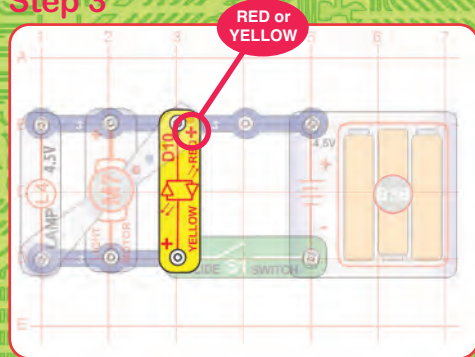

Step 4

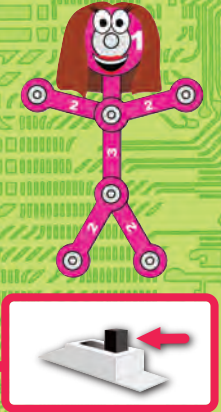
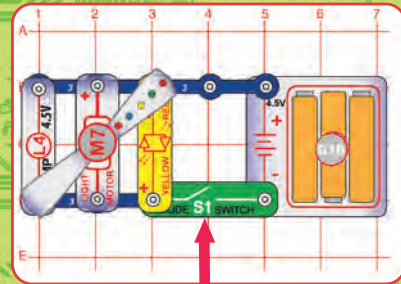

Project 21 : Egg Horn

Step 1

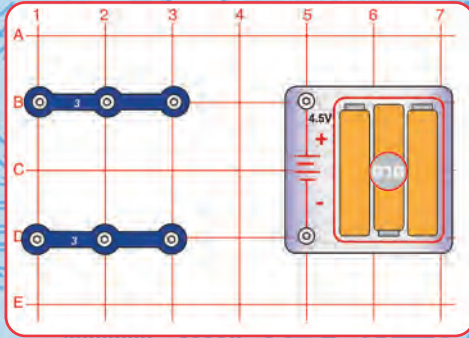

Step 2

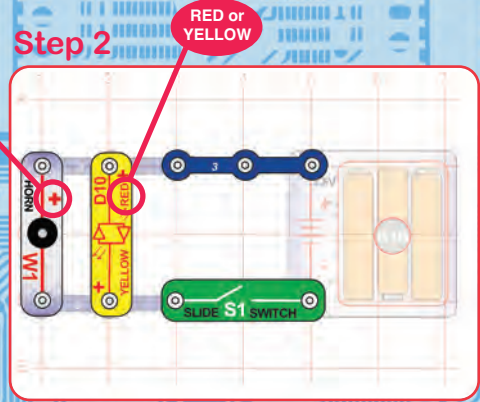

Step 3

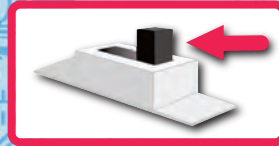
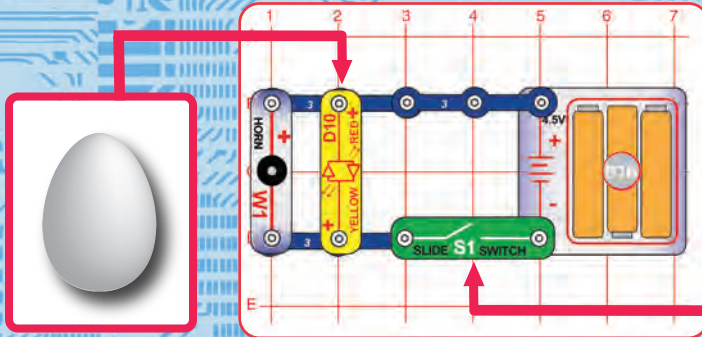

SCB-20 Block Layout

Important: If any parts are missing or damaged, **DO NOT RETURN TO RETAILER.**
Call Customer Service toll-free at (800) 533-2441 or e-mail us at: help@elenco.com.

Note: A complete parts list is on page 2 in this manual.

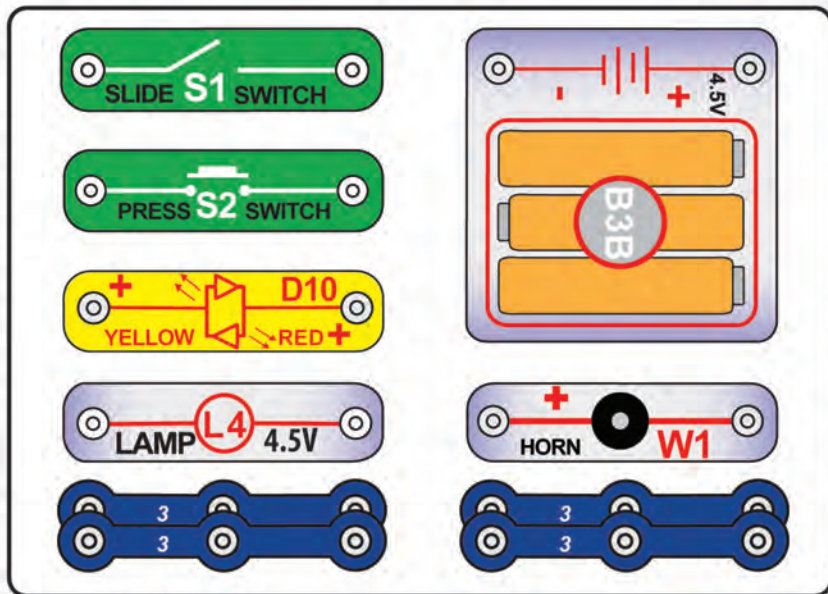
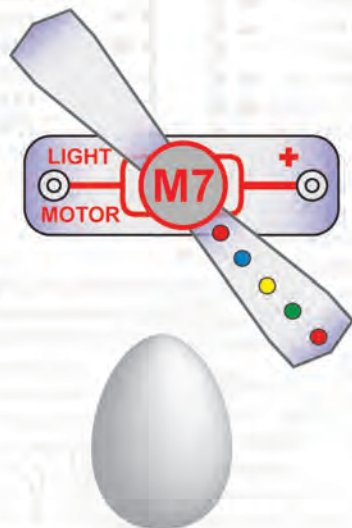

ELENCO®

150 Carpenter Ave. Wheeling, IL 60090 U.S.A.

Call us at: (847) 541-3800 • E-mail us at elenco@elenco.com

Visit us at: www.elenco.com / www.snapcircuits.net

Copyright© 2015 All rights reserved Colors and styles may vary.

Made in China