

LED Fun

Model SCP-11

WARNING: Always check your wiring before turning on a circuit. Never leave a circuit unattended while the batteries are installed. Never connect additional batteries or any other power sources to your circuits.

CAUTION: High intensity light. Do not look directly at the white or blue LEDs (D6 & D9).



WARNING: SHOCK HAZARD - Never connect Snap Circuits® to the electrical outlets in your home in any way!

Project 1 Light Slider

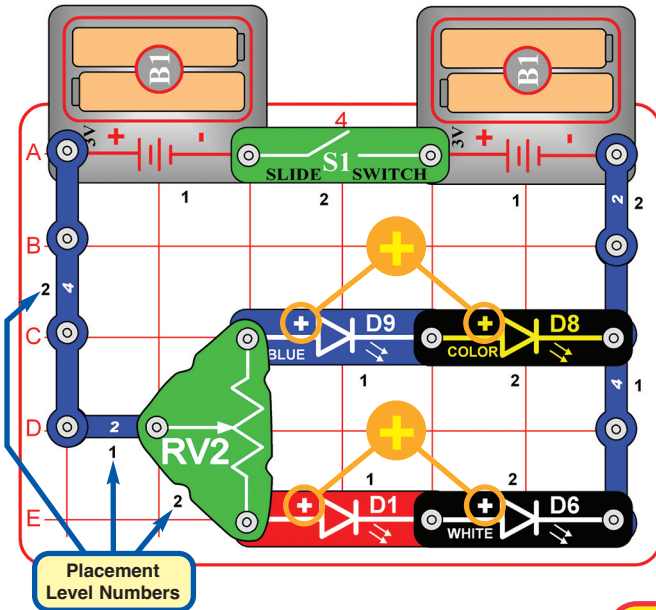

Place fiber optic tree & mounting base on any LED



This circuit is pictured on the front of the box, use that picture to help in building it.

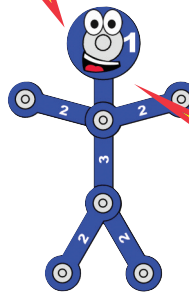

Snap Circuits® uses electronic blocks that snap onto a base grid to build different circuits. These blocks have different colors and numbers on them so that you can easily identify them. Build the circuit shown by placing all the parts with a black 1 next to them on the clear base grid first. Then, assemble parts marked with a 2. Install two (2) "AA" batteries (not included) into each of the battery holders (B1). Lay the mounting base on any LED (D1, D6, D8, or D9) and place the fiber optic tree in it.

Turn on the slide switch (S1). Move the lever on the adjustable resistor (RV2) around to change the brightness of the LEDs. The blue & color LEDs will be blinking. For best effects, place the circuit in a dimly lit room. Also, try swapping the the LEDs with each other.

Project 2 Color Light

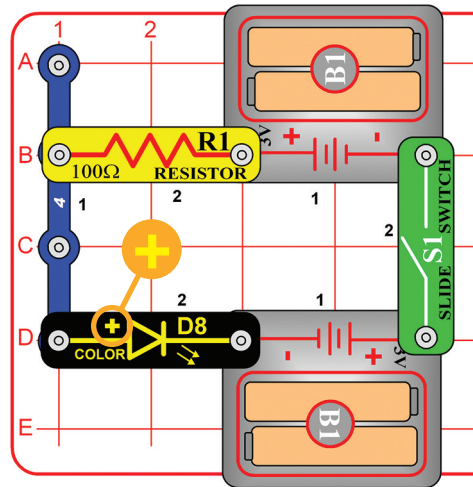

If desired, place fiber optic tree & mounting base on color LED



The batteries (B1) push electricity through the circuit. The switch (S1) turns the electricity on or off. Resistors (like R1) limit and control the flow of electricity. LEDs are light emitting diodes, which convert electrical energy into light; the color of the light emitted depends on the characteristics of the material used in them. LEDs are more energy efficient than normal light bulbs. The color LED contains red, green, and blue LEDs, with a micro-circuit controlling them.

Build the circuit as shown, and turn on the slide switch (S1). The color LED (D8) is changing colors in a repeating pattern. If desired, place the fiber optic tree and mounting base on the color LED. For best effects, place the circuit in a dimly lit room.

Next, replace the color LED (D8) with the red, white, or blue LEDs (D1, D6, & D9).

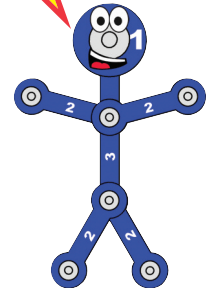
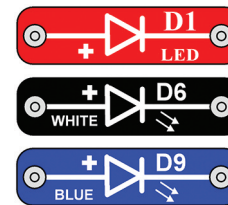

Project 3 Spectrum of Light

Prismatic film separates light into different colors, and can make interesting light effects. White light is a combination of all colors.

Use the circuit from project 2, but look at each of the LEDs through the prismatic film. Prismatic film is the approximately 1.5" x 1" plastic sheet that is included in this kit. The white LED will give the most impressive effects. Next, view different light sources in and around your home through the prismatic film.

Prismatic film



If you have any problems, contact Elenco®

Project 4 Adjustable Light

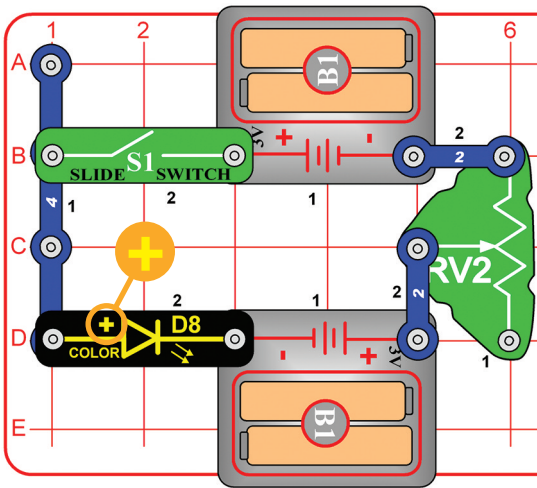

If desired, place fiber optic tree & mounting base on color LED



Build the circuit as shown, and turn on the slide switch (S1). Move the lever on the adjustable resistor (RV2) to vary the brightness of the color LED (D8). If desired, place the fiber optic tree and mounting base on the color LED. For best effects, place the circuit in a dimly lit room. Next, replace the color LED (D8) with the red, white, or blue LEDs (D1, D6, & D9).

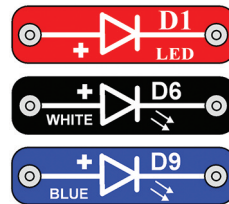

Project 6 Adjustable Row of Lights

Use the project 5 circuit but replace the 100Ω resistor (R1) with the adjustable resistor (RV2), connected as shown. Move the lever on RV2 around and compare the circuit to project 5. Try using only two or three of the LEDs at once.

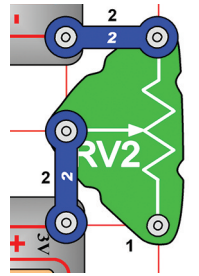

RV2 has higher resistance on all settings than R1 did, which limits the flow of electricity much more than in project 5. RV2 can be adjusted from 200Ω to 10,000Ω.

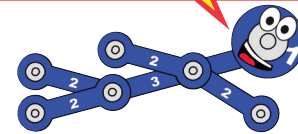

Project 5 Row of Lights

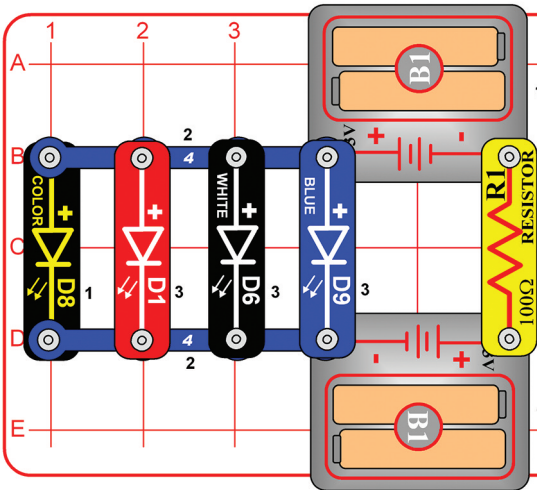

Red light is easier for LEDs to produce than the other colors. When all the LEDs are connected in parallel like they are here, the red LED will dominate because it turns on more easily. Resistor R1 limits the flow of electricity from the batteries, and the red LED takes most of it. The other LEDs may not get enough electricity, especially when there is only one set of batteries. When electricity is limited, the color LED can make red light more easily than other colors.

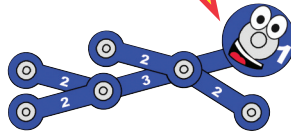

The switch (S1) isn't used here, so this circuit will always be on. The red LED (D1) will be bright, but the brightness of the other LEDs (D6, D8, & D9) may vary. If you remove the red LED from the circuit then the others get brighter. For best effects, take the circuit into a dimly lit room. Place the fiber optic tree on one LED if desired.

Now replace one of the battery holders (B1) with the switch (S1), and turn it on. The red LED is bright, the blue & white LEDs may be dim or off, and the color LED may only be flashing red. Now remove the red LED from the circuit and see if the others get brighter.

Project 7 Blinking Colors

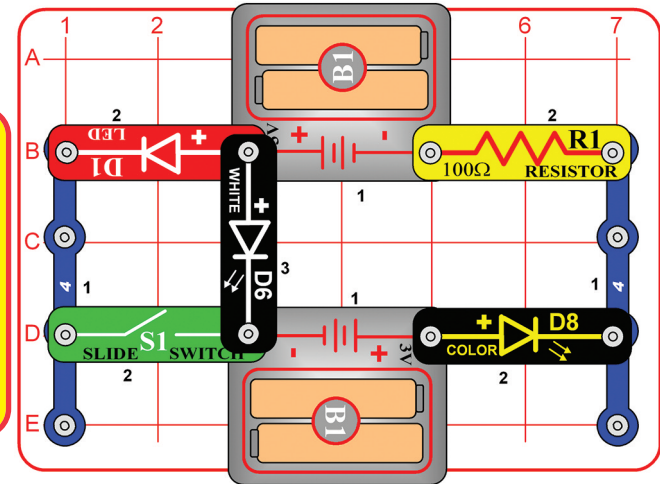

When the red and white LEDs are connected in parallel (which happens when S1 is on), the red LED will dominate because it turns on more easily. The blue LED will perform similarly to the white LED.

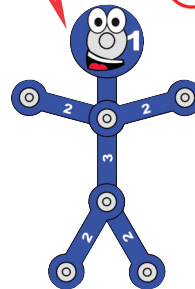

Leave the switch (S1) off at first; the white and color LEDs (D6 & D8) are blinking. Now turn on the switch; the red LED (D1) is blinking but the white LED is off.

If you swap the locations of the red and white LEDs, then the red LED will be blinking and the white LED will be off, and turning on the switch won't change anything.

Try replacing any of the LEDs with the blue LED (D9), or swapping any of them with the color LED.

Project 8 Double Light

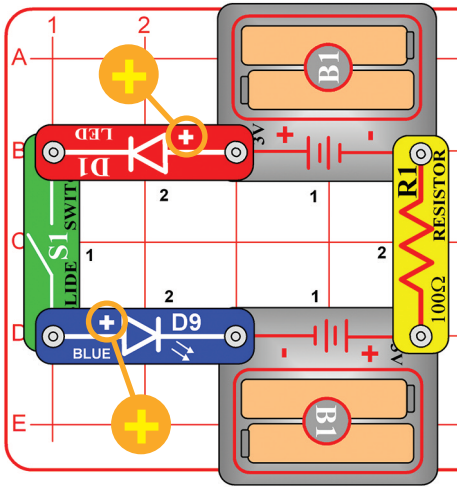

This circuit has the LEDs connected in a series (not in parallel, as in project 5). This arrangement makes the LEDs dimmer, but makes the batteries last longer.

By using different materials and manufacturing processes, LEDs can be made for different brightness and for wide/narrow angles of view. The red LED is not as bright as the others, and can be viewed from a wider angle; LEDs like this might be used as indicators. The white LED is very bright especially when looking directly at it; LEDs like this might be used in flashlights.

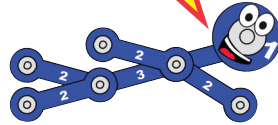

Turn on the switch (S1). The red & blue LEDs (D1 & D9) will be on. Try replacing either or both of them with the white and color LEDs (D6 & D8); try all combinations. If the color LED is used then both will be blinking. For best effects, take the circuit into a dimly lit room. Place the fiber optic tree on one LED if desired.



Project 10 Series of Lights

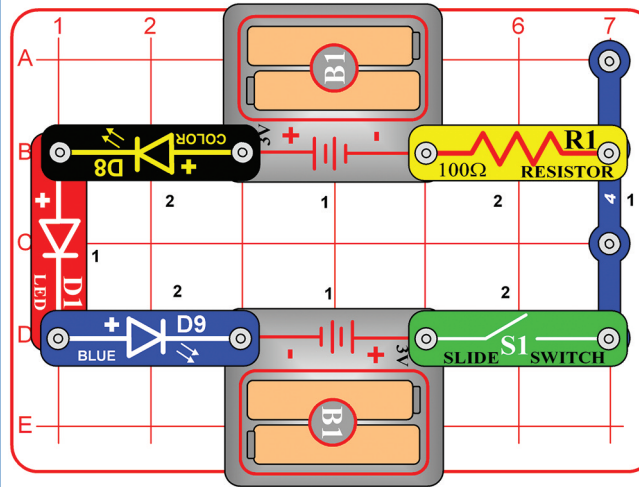

LEDs are like special one-way light bulbs. They have a "turn-on threshold" of voltage (about 1.5V for red, 2.0V for green, and 3.0V for blue or white) that must be exceeded before light is produced, brightness then depends on the circuit resistance. This circuit has 3 LEDs in series, so the battery voltage must exceed all of their turn-on thresholds before any light is produced.

Turn on the switch (S1). The LEDs (D1, D8, & D9) will be dim, and some may not light at all. Try viewing them in a dimly lit room. You can replace the blue LED with the white LED (D6), but if you replace the others then none may light.

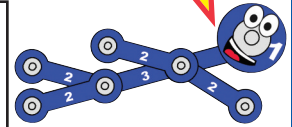

Project 9 Adjustable Double Light

Use the project 8 circuit but replace the 100Ω resistor (R1) with the adjustable resistor (RV2), connected as shown. Move the lever on RV2 around and compare the circuit to project 8, with all combinations of LEDs.

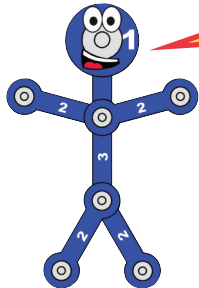
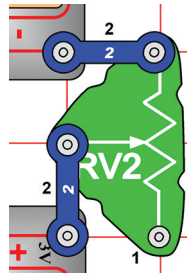

What is Resistance? Take your hands and rub them together very fast. Your hands should feel warm. The friction between your hands converts your effort into heat. Resistance is the electrical friction between an electric current and the material it is flowing through.

The white LED is the brightest LED, due to its material and manufacturing process.

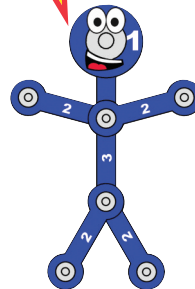

Project 11 Brightness Comparator

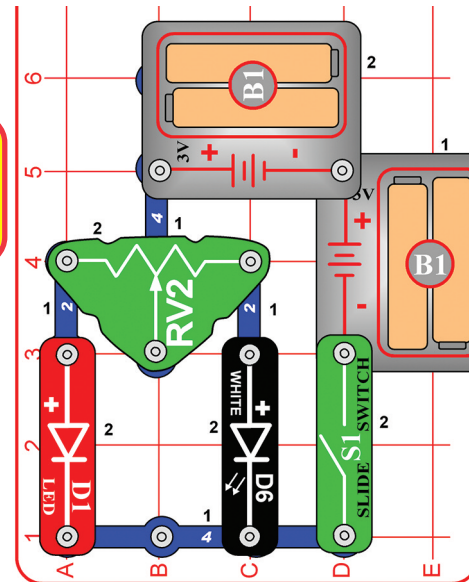

In building the circuit, note that one of the 4-snap wires is partially beneath the adjustable resistor (RV2) and one of the battery holders (B1). Turn on the switch (S1) and move the lever on the adjustable resistor around. Compare the brightness of the LEDs (D1 & D6), then replace either or both of them with the blue and color LED (D8 & D9). Try all LED combinations. For best effects, place the circuit in a dimly lit room.



OTHER SNAP CIRCUITS® PRODUCTS!

Contact Elenco® to find out where you can purchase these products.

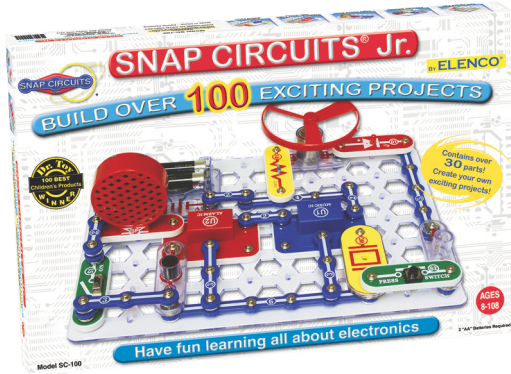

Snap Circuits® Jr. Model SC-100

Build over 100 projects, contains over 30 parts.



Snap Circuits® Light Model SCL-175

Build over 175 projects, contains over 55 parts.



Snap Circuits® Green Model SCG-125

Build over 125 projects, contains over 40 parts.

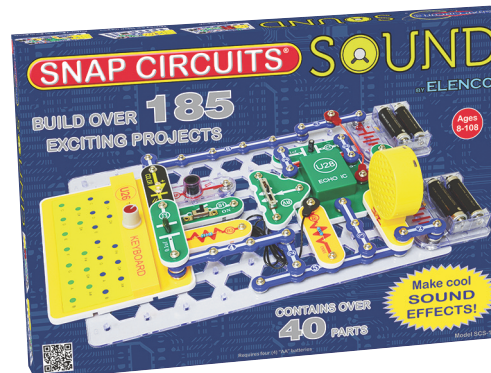

Snap Circuits® Sound Model SCS-185

Build over 185 projects, contains over 40 parts.



Flying Saucer Plus Basic Electricity

Model SCP-09

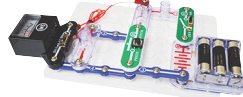

Model SCP-10

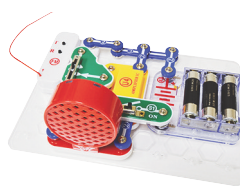

FM Radio

Model SCP-12

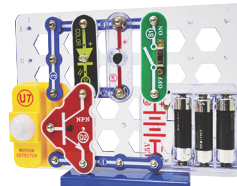

Motion Detector

Model SCP-13

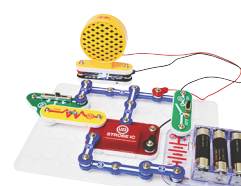

Strobe Light & Sound

Model SCP-14

PARTS LIST

Qty.	ID	Name	Part #
<input type="checkbox"/>	2	2-snap wire	6SC02
<input type="checkbox"/>	4	4-snap wire	6SC04
<input type="checkbox"/>	B1	Battery holder	6SCB1
<input type="checkbox"/>		Base grid	6SCBGMF
<input type="checkbox"/>	D1	Red LED	6SCD1
<input type="checkbox"/>	D6	White LED	6SCD6
<input type="checkbox"/>	D8	Color LED	6SCD8
<input type="checkbox"/>	D9	Blue LED	6SCD9
<input type="checkbox"/>		Prismatic film	6SCFILM
<input type="checkbox"/>		Fiber optic tree	6SCFT
<input type="checkbox"/>		Mounting base	6SCFMB
<input type="checkbox"/>	R1	100Ω resistor	6SCR1
<input type="checkbox"/>	RV2	Adjustable resistor	6SCRV2
<input type="checkbox"/>	S1	Slide switch	6SCS1

Important: If any parts are missing or damaged, **DO NOT RETURN TO RETAILER.** Call toll-free (800) 533-2441 or e-mail us at: help@elenco.com.
Customer Service • 150 Carpenter Ave. • Wheeling, IL 60090 U.S.A.

You may order additional / replacement parts at our website: www.snapcircuits.net

BATTERIES:

- Use only 1.5V AA type, alkaline batteries (not included).
- Insert batteries with correct polarity.
- Non-rechargeable batteries should not be recharged. Rechargeable batteries should only be charged under adult supervision, and should not be recharged while in the product.
- Do not mix alkaline, standard (carbon-zinc), or rechargeable (nickel-cadmium) batteries.
- Do not mix old and new batteries.
- Remove batteries when they are used up.
- Do not short circuit the battery terminals.
- Never throw batteries in a fire or attempt to open its outer casing.
- Batteries are harmful if swallowed, so keep away from small children.